

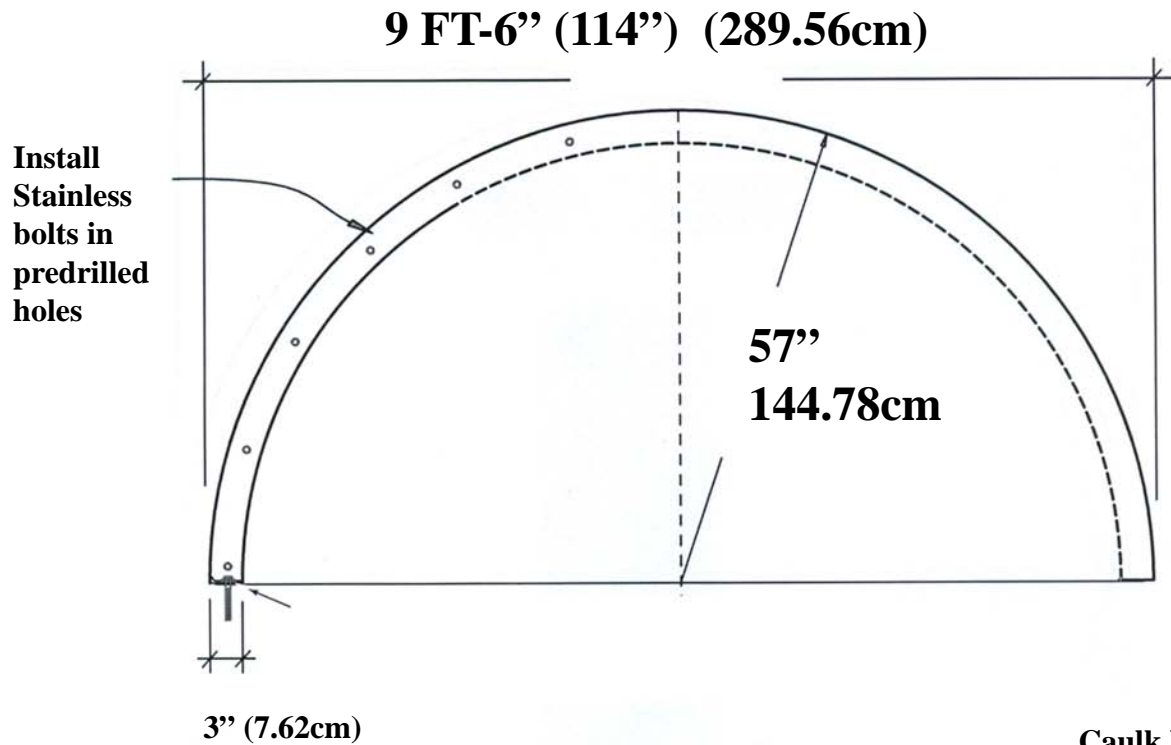

Exterior Dome IPDM5011

Martin Richards Design
COLLECTION



8 PIECES

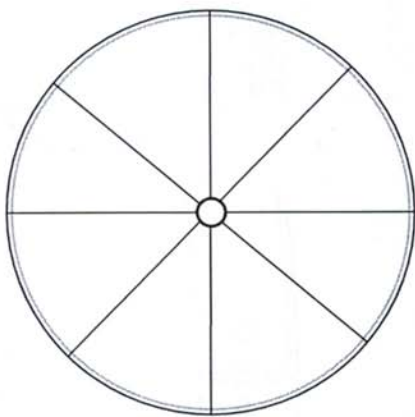

Weight 420 lbs 190.51 kg

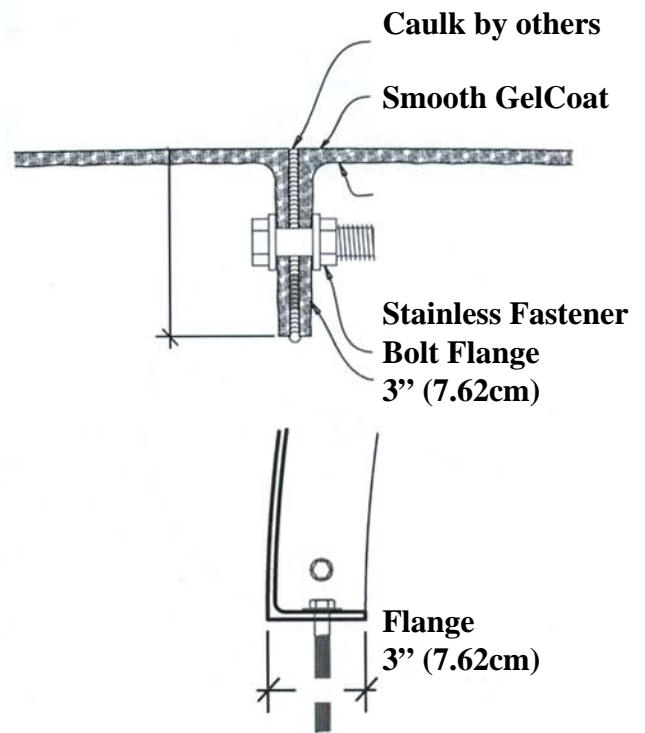

* All specifications subject to change without notice, Final products & Measurements may vary from this brochure



Imperial Productions®

1-800-399-7585

Imperial Productions & Distribution Inc Toronto / New York

email sales@imperialproductions.com copyright 2016 MRDCI All Rights Reserved

JUL-20